

## Product specification sheet

### Floor socket/box

#### Designation:

Type:	STAKOHOME-8802-B	2 power sockets 230V
Type:	STAKOHOME-8802-Bnw	1 power socket 230V, 2 sockets RJ45 CAT6a
Type:	STAKOHOME-8802-Bnw	1 power socket 230V, 1 TV-SAT

**Other types (different instrumentation) upon request., is possible.**

#### Description:

A floor socket made of solid aluminium alloy with an insertion lid.

The lid can be closed even when standard plugs of straight or bent design are connected to the sockets. Dimensions approx. 125x125x70 mm. Power is supplied into the socket by means of 2 incoming feeder cables of 25 mm diameter.

When installed professionally into a mortar bed, it can withstand the weight of a passenger car driving over it. Adjustments screws provide for slight height adjustment of the lid (within approx. 5 mm).

Recommended installation procedure: Remove the lid which covers the installation site from the monolithic floor finish. Remove the socket bracket/holder from the installation tray. Fill the installation tray with paper or a similar material. Push the floor socket into the mortar bed - use a spirit level and align it with the floor level. Slide an empty tube into the 25 mm opening. The rest shall be later filled up with mortar/adhesive. Trim the parquet lid to 125x125 mm (careful with the orientation of the wood grain pattern!) Adhere the aluminium plate of dimensions 115x115 mm to the parquet plate and make sure it is centred in relation to the parquet plate. Provide openings for cable outlets at the specified locations. The cut-out in the parquet floor shall be of dimensions 127x127 mm. The lid shall fit in the cut-out in a precise manner. The clearance round its edges shall be approx. 1 mm wide. The electrical connections must be carried out by a professional company/person with necessary qualifications.

**Maintenance: The drawers must be regularly checked and cleaned.**

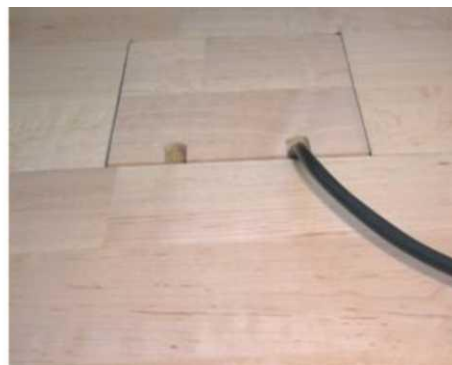

#### Scope of application:

houses, apartments, offices, car show rooms, shops, banks etc. (IP20)

#### Technical data:

Material:

Body - aluminium alloy / lid - aluminium

Dimensions:

approx 125x125x67,5mm

Weight:

approx 1250 g

Load-carrying capacity:

200 kg

Sockets/instrumentation:

230V, VGA, RJ45, XLR, SAT, HDMI, USB etc.

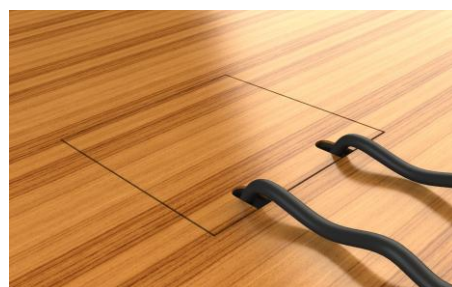

Note: Printing errors and alterations reserved

**stakohome®**

Stakohome Network s.r.o.  
IČ: 27213064, DIČ/VAT: CZ27213064  
tel.: +420 226 517 522  
fax: +420 226 517 379  
stakohome@stakohome.cz  
www.stakohome.cz  
www.intelligentni-byt.cz

Invoice address: Podnikatelská 565, 190 11 Prague 9, Běchovice, Czech Republic  
Showroom and address: Aloisovská 934/8, 198 00 Prague 9, Hloubětín, Czech Republic

## Technical sheet

### Floor box

#### Designation:

Type:	STAKOHOME-8802-B	2x power sockets 230V
Type:	STAKOHOME-8802-Bnw	1x power socket 230V, 2x RJ45 cat.6a
Type:	STAKOHOME-8802-Bnw	1x power socket 230V, 1x modul USB charger for two device
<b>Other types (different instrumentation) upon request, is possible</b>		

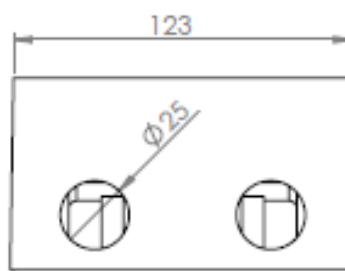
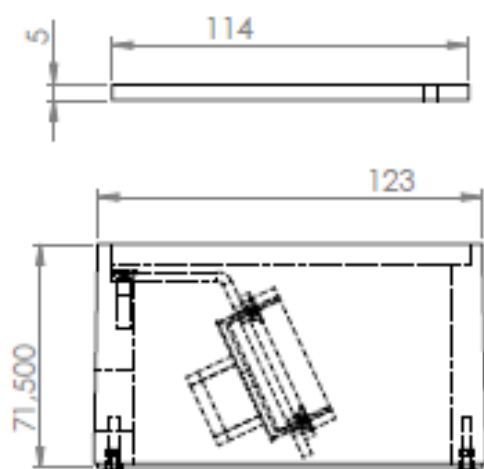
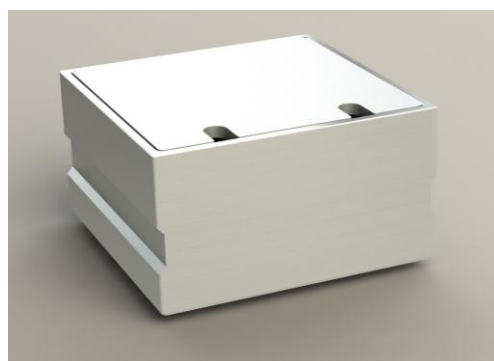
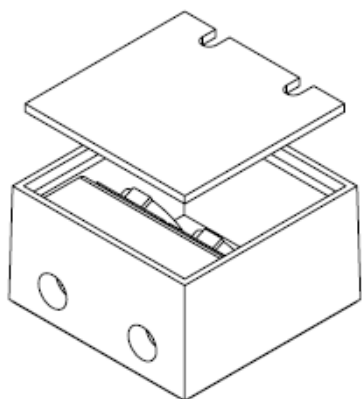

The lid is inserted into the box

Printing errors and changes reserved

**stakohome®**

Stakohome Network s.r.o.  
IČ: 27213064, DIČ/VAT: CZ27213064  
tel.: +420 226 517 522  
fax: +420 226 517 379  
stakohome@stakohome.cz  
www.stakohome.cz  
www.intelligentni-byt.cz

Invoice address: Podnikatelská 565, 190 11 Prague 9, Běchovice, Czech Republic  
Showroom and address: Aloisovská 934/8, 198 00 Prague 9, Hloubětín, Czech Republic

## Installation - variant for concrete

(for types STAKOHOME-8802-B, STAKOHOME-8803-B, STAKOHOME-8804-B, STAKOHOME-8808-B, STAKOHOME-8810-B)

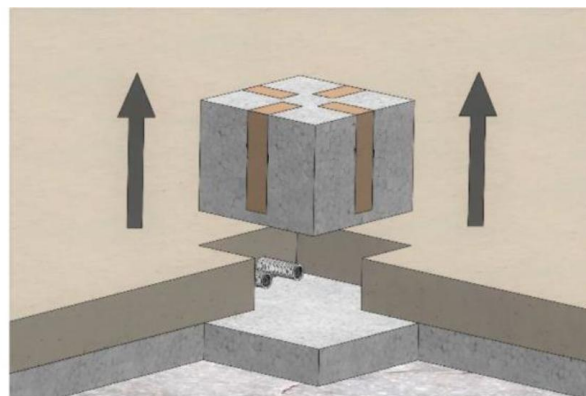
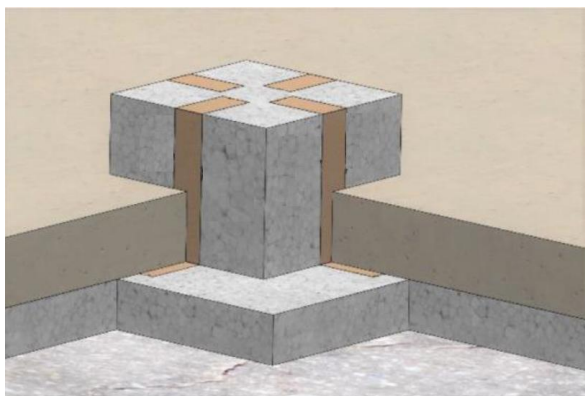

Place for floor socket/ First set up box, made from polystyrene or formwork (size should be 2-4 cm bigger than corresponding box for floor socket. After pouring concrete, remove polystyrene.

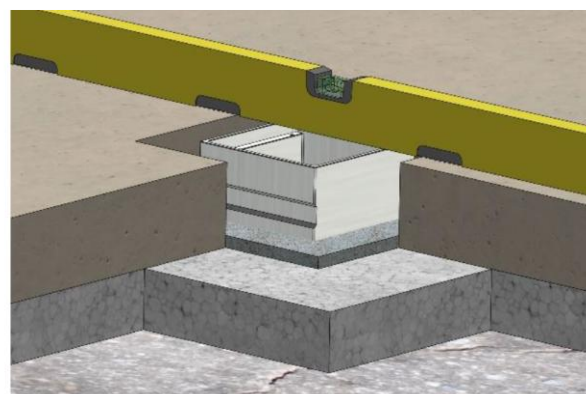
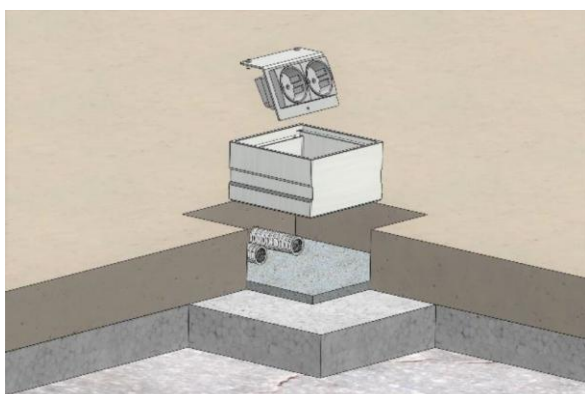

Insert pipe/s with wires into set holes (25mm). Attached end caps Ø25 are for unused hole. This end caps can be used as bushing (need to drill holes into it) for specific wires, it's possible to take out socket holder (including sockets) to prevent any damage during install. Floor box is pushed by water level into mortar/glue basis. Upper edge of the box should be levelled with concrete

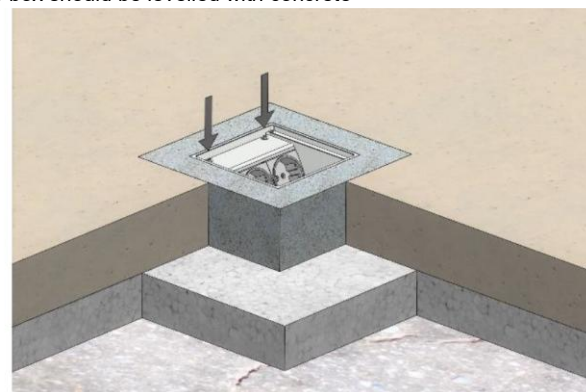
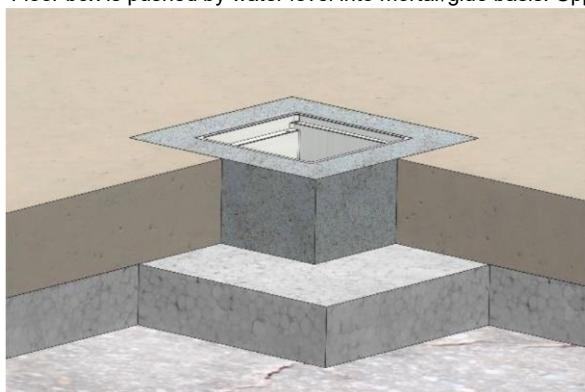

Rest of the empty space around floor box is filled by glue/mortar etc. Fill it to the same level as surrounding concrete floor. Prepared wires will connect to corresponding sockets and socket holder is inserted back.

**stakohome®**

**Stakohome Network s.r.o.**  
 IČ: 27213064, DIČ/VAT: CZ27213064  
 tel.: +420 226 517 522  
 fax: +420 226 517 379  
[stakohome@stakohome.cz](mailto:stakohome@stakohome.cz)  
[www.stakohome.cz](http://www.stakohome.cz)  
[www.inteligentni-byt.cz](http://www.inteligentni-byt.cz)

Invoice address: Podnikatelská 565, 190 11 Prague 9, Běchovice, Czech Republic  
 Showroom and address: Aloisovská 934/8, 198 00 Prague 9, Hloubětín, Czech Republic

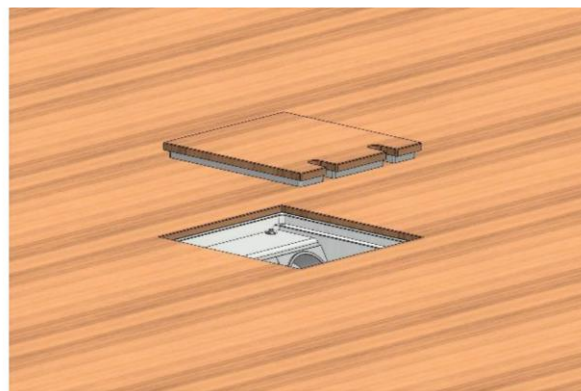
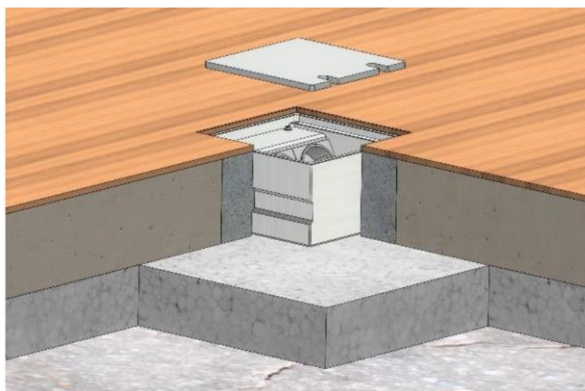

Cut the lid from floor material (Be careful about wood patterns!), size 125x125mm or depends on size of the hole made for the box. Glue aluminium lid (115x115mm) to the lid from floor material; be sure it's glued in the centre. Cut openings in relevant places for electric cords. If multiple holes not needed, you don't have to cut them out)

Lid should fit precisely into cut hole. Space between lid and floor should be max 1mm or less. Be careful about placement of the lid to be possible connect cords from electric devices.

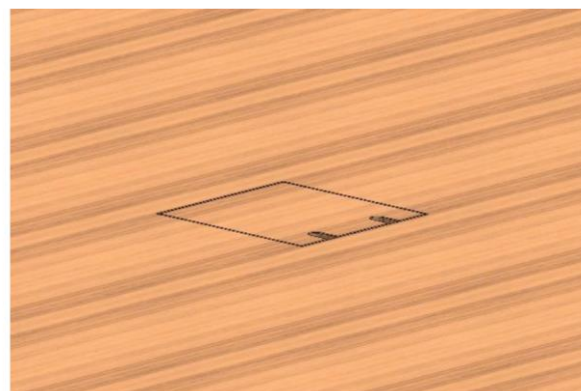
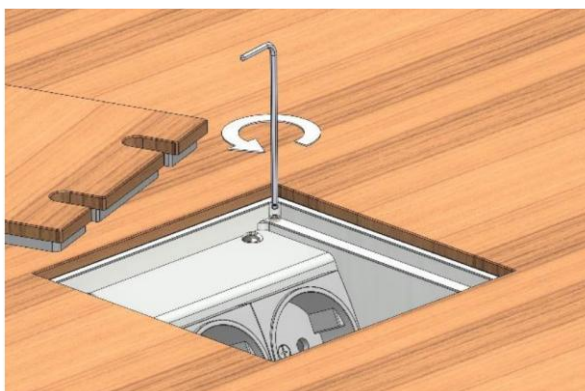

4 spacing screws, which are always located in the corner of the box, allow for a slight (approx. 5 mm) adjustment of the lid height (lid lifting) so that the lid is in the same plane as the floor covering around the floor box.